

CC408



Operators Guide  
Solution 880

**BOSCH**

## Copyright Notice

Unless otherwise indicated, this publication is the copyright of Bosch Security Systems Pty Ltd (“**Bosch**”). All rights are reserved.

You may download a single copy of this publication. By downloading the publication you agree that you will: (i) only use the publication for your own reference; (ii) not commercially exploit or charge any person for the use of the publication; and (iii) not modify the publication in any way without the prior written permission of Bosch.

Except as specified above or where authorised by the Copyright Act 1968 (Cth), no part of this publication may be reproduced, transmitted, modified or stored, in any form or by any means, without the prior written permission of Bosch.

## Notice of Liability

This material is designed for use by tradespeople with expertise in the installation of this product. Persons without appropriate expertise should seek assistance before attempting installation.

While care was taken in the preparation of this material, Bosch Security Systems Pty Ltd and its representatives are not responsible to any person or entity for any loss or damage directly or indirectly caused by information in, or any omission from, this material.

Bosch Security Systems Pty Ltd reserves the right to make changes to features and specifications of its products at any time without prior notification.

## New Zealand Telepermit Notes

The grant of a telepermit for a device in no way indicates Telecom acceptance of responsibility for the correct operation of that device under all operating conditions.

This equipment will not be used in any manner that could constitute a nuisance to other telecom customers.

Immediately disconnect this equipment should it become physically damaged and arrange for its disposal or repair.

The transmit level from this device is set at a fixed level and because of this, there may be circumstances where the performance is less than optimal. Before reporting such occurrences as faults, please check the line with a standard telepermitted telephone and do not report a fault if the telephone performance is satisfactory.

This device is equipped with pulse dialling while the Telecom standard is DTMF tone dialling. There is no guarantee that Telecom lines will always continue to support pulse dialling.

Use of dialling, when this equipment is connected to the same line as other equipment, may give rise to bell noise and also cause a false answer condition. Should such problems occur, the user should **not** contact the Telecom Faults Service.

This equipment is set up to carry out test calls at pre-determined times. Such test calls interrupt any other calls that may be set up on the line at the same time. The timing set for such test calls should be discussed with the installer.

The timing set for test calls from this equipment may be subject to drift. If this proves to be inconvenient and your calls are interrupted, then the problem of timing should be discussed with the equipment installer. The matter should **not** be reported as a fault to Telecom Faults Service.

This equipment shall not be set up to make automatic calls to the Telecom 111 Emergency Service.

This equipment should not be used under any circumstances that may constitute a nuisance to other Telecom customers.

In the event of any problem with this device, the systems battery, AC mains supply, and telephone line should be disconnected. The user is to arrange with the supplier of the device to make the necessary repairs.

Should the matter be reported to Telecom as a wiring fault and the fault proven to be due to this product, a call-out charge will be incurred.

## Contents

1.	Introduction .....	5	15.	Reset Latching Outputs .....	14
2.	Specifications .....	5	16.	Codepad ID/Buzzer Tone Change .....	14
3.	Features .....	5	17.	Testing.....	14
4.	Codepad Indicators.....	6	17.1	Horn Speaker Test.....	14
4.1	Zone Indicators.....	6	17.2	Bell Test .....	14
4.2	AWAY Indicator .....	6	17.3	Strobe Test.....	14
4.3	STAY Indicator .....	6	17.4	Walk Test Mode.....	14
4.4	System Disarmed.....	6	17.5	Test Report .....	14
4.5	MAINS Indicator .....	7	18.	Event Memory Recall.....	15
4.6	Off Indicator/Zone Sealed .....	7	19.	Day Alarm .....	15
4.7	On Indicator/Zone In Alarm.....	7	20.	Remote Arming By Telephone .....	15
4.8	FAULT Indicator .....	7	21.	Domestic Dialling .....	16
4.9	Audible Indications.....	7	21.1	Acknowledging Domestic Calls.....	16
5.	Arming the System.....	7	21.2	Programming Domestic Telephone Numbers.....	16
5.1	Arming in AWAY Mode.....	8	21.3	Disable Domestic Dialling .....	16
5.2	Arming in STAY Mode 1.....	8	22.	Partitioning .....	17
5.3	Arming in STAY Mode 2.....	8	22.1	Master Partitioned Codepad Indicators.....	17
5.4	Programming STAY Mode 2 Zones .....	9	22.1.1	Zone Indicators .....	17
6.	Disarming the System.....	9	22.1.2	Area On/Off Indicators.....	17
7.	User Codes.....	9	22.2.1	Area Display Indicators.....	17
7.1	Adding User Codes.....	9	22.2.2	Status Indicators .....	17
7.2	Adding Radio Remote User Codes.....	9	22.3	Operating From A Master Partitioned Codepad.....	17
7.3	Deleting User Codes/Radio User Codes.....	9	22.4	Operating From Area Addressable Codepads .....	17
8.	Radio Transmitter Operations.....	10	23.	Basic Pager Reporting .....	18
9.	Alarms .....	10	24.	Glossary of Terms.....	20
9.1	Duress Alarm.....	10	25.	Installation Notes .....	22
9.2	Panic Alarm .....	10			
9.3	Fire Alarm.....	11			
9.4	Medical Alarm.....	11	<b>Figures</b>		
9.5	Tamper Alarm (Access Denied) .....	11	Figure 1:	CP5 Eight Zone LED Codepad.....	6
10.	Isolating Zones.....	11	Figure 2:	CP5 Eight Zone LCD Codepad .....	6
10.1	Standard Isolating .....	11	Figure 3:	RE012 – 2 Channel Keyfob Transmitter .....	10
10.2	Code to Isolate .....	11	Figure 4:	RE013 – 4 Channel Keyfob Transmitter .....	10
11.	Setting the Date and Time .....	11	Figure 5:	CP5 LED Codepad Showing Audible Alarm Buttons .....	10
12.	Fault Analysis Mode .....	12	Figure 6:	Master Partitioned Codepad.....	17
12.1	AC Fail.....	12	Figure 7:	Basic Pager Display .....	19
12.2	System Faults .....	12			
12.3	Fault Descriptions.....	12			
13.	Telco Arm/Disarm Sequence (Call Forward On/Off) .....	13			
13.1	Telco Arm Sequence.....	13			
13.2	Telco Disarm Sequence.....	13			
14.	Turning Outputs On/Off.....	14			

**Tables**

Table 1:	Specifications .....	5
Table 2:	Zone Indicator .....	6
Table 3:	AWAY Indicator .....	6
Table 4:	STAY Indicator .....	6
Table 5:	MAINS Indicator .....	7
Table 6:	FAULT Indicator .....	7
Table 7:	Audible Indicators.....	7
Table 8:	Arming Methods .....	7
Table 9:	Keyfob Audible/Visual Indications .....	10
Table 10:	Fault Condition Indicators .....	12
Table 11:	Telco Arm/Disarm Dialling Digits.....	13
Table 12:	Domestic Dialling Telephone Digits .....	16
Table 13:	Zone Status Display Descriptions.....	18
Table 14:	System Status .....	18
Table 15:	Glossary of Terms .....	20

## 1. Introduction

Congratulations on selecting the Solution 880 Model CC408 Control Panel to protect you and your property. To obtain the most from your unit, take the time to read through this manual and familiarise yourself with the operating features of this system. In all aspects of planning, engineering, styling, operation, convenience, and adaptability, we have sought to anticipate your every possible requirement.

Programming simplicity and speed were some of the major considerations and we believe that our objectives in this area were more than satisfied.

This guide explains all aspects of operating the control panel. All system parameters and options are detailed. Suitability is left up to the individual. Every system can be tailored to meet all requirements quickly and easily.

## 2. Specifications

**Table 1: Specifications**

<b>Temperature Range</b>	0°C to +45°C (+32°F to +113°F)
<b>Humidity</b>	10% to 95%
<b>Power Source</b>	TF008 Plug Pack – 240 VAC/18 VAC @ 1.3 A
<b>Stand-By Current</b>	65 mA
<b>Current Draw In Alarm Condition</b>	115 mA
<b>Current Draw In Alarm Condition with Codepad</b>	105 mA
<b>Back-Up Battery</b>	6 Ah/12 VDC Rechargeable sealed lead acid battery
<b>Dimensions (case, packed in carton)</b>	30.6 cm x 26.2 cm x 8.4 cm (12.05 in. x 10.31 in. x 3.31 in.)
<b>Weight</b>	2.5 Kg (5.51 lb.)
<b>Supplier Code</b>	N771
<b>New Zealand Telepermit</b>	PTC 211/98/083
<b>Malaysia Approval Number</b>	Pending



The Austel permit issued for this product is subject to the following conditions:  
The Solution 880 Model CC408 Control Panel can only be powered by a Bosch Security Systems TF008 Plug Pack (Approval Number Q92128).



Test the sirens, strobe, and zones at weekly intervals. See *Section 17 Testing* for further information.

## 3. Features

The Solution 880 Control Panel uses the latest in microprocessor technology to provide you with more useful features and superior reliability and performance. The main features of the control panel are listed below:

- Eight programmable User Codes
- STAY Mode and AWAY Mode operation
- Six programmable burglary zones
- Two programmable 24-hour zones
- Siren and/or dialler lockout per zone
- Delayed reporting
- Built-in telephone fail monitor
- Day alarm
- Remote arming
- Answering machine bypass
- Event memory recall
- Upload/download programmable
- Auxiliary output (Output 2)
- Relay output
- Eight radio remote user codes
- Entry and exit warning beeper
- EDMSAT – satellite siren compatible
- Separate fire alarm sound
- Dual reporting
- Sensor watch
- Dynamic battery testing
- Automatic arming/automatic disarming
- AC fail and system fault indicators
- Walk Test Mode
- Monitored siren output (Output 1)
- Strobe output
- Telco arm/disarm sequence (call forwarding)

## 4. Codepad Indicators

Figure 1: CP5 Eight Zone LED Codepad

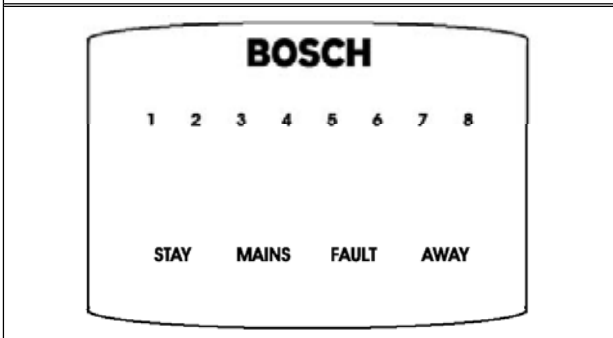
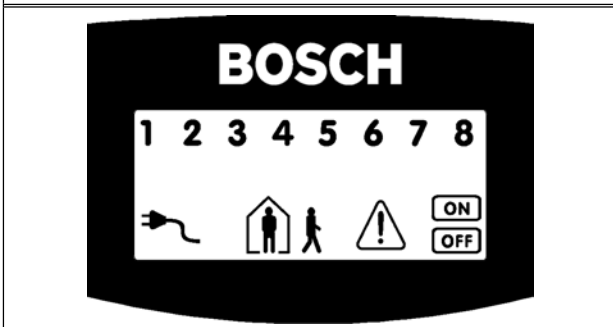

Figure 2: CP5 Eight Zone LCD Codepad



The codepad is the communications interface between you and your alarm system. Use the codepad to issue commands. The codepad offers both visual and audible indications that guide you through the general operation.

The codepad incorporates numerous indicators. There are zone indicators that show the condition of each zone and four other indicators for general status. The following pages outline a list of situations and the relevant indicators that are seen.

### 4.1 Zone Indicators

**1 2 3 ....** The zone indicators (1 to 8) display the status of the zones. *Table 2* lists the various situations that the indicators display (such as, Zone Sealed/Zone Unsealed).

Table 2: Zone Indicator

Zone Indicator	Definition
On	Zone is unsealed.
Off	Zone is sealed.
Flashing Fast (0.25 seconds on/ 0.25 seconds off)	Zone is in alarm condition.
Flashing Slow (1 second on/ 1 second off)	Zone is manually isolated or selected to be isolated.

### 4.2 AWAY Indicator



The AWAY indicator displays the system is armed in AWAY Mode. The AWAY indicator also flashes in unison with the STAY indicator when programming various options throughout the *Operators Guide*.

See *Section 5.1 Arming in AWAY Mode* for information on the different methods of arming the system in AWAY Mode.

Table 3: AWAY Indicator

AWAY Indicator	Definition
On	System is armed in AWAY Mode.
Off	System is not armed in AWAY Mode.

### 4.3 STAY Indicator



The STAY indicator displays the system is armed in STAY Mode 1 or STAY Mode 2. The STAY indicator also flashes in unison with the AWAY indicator when programming various options throughout the *Operators Guide*.

See *Section 5.2 Arming in STAY Mode 1* for different methods of arming in STAY Mode 1. See *Section 5.3 Arming in STAY Mode 2* to arm in STAY Mode 2.

Table 4: STAY Indicator

STAY Indicator	Definition
On	System is armed in STAY Mode 1 or STAY Mode 2.
Off	System is not armed in STAY Mode 1 or STAY Mode 2.
Flashing twice a second	Zone Isolating Mode or setting STAY Mode 2 zones.
Flashing once every 3 seconds	Day alarm status – day alarm turned on.

### 4.4 System Disarmed



This indicator displays with the **OFF** indicator when the system is disarmed.

### 4.5 MAINS Indicator



The MAINS indicator displays the systems AC mains supply is normal or failed.

**Table 5: MAINS Indicator**

MAINS Indicator	Definition
On	AC mains power normal.
Flashing	AC mains supply failed.

### 4.6 Off Indicator/Zone Sealed



The **OFF** indicator displays when the system is in the disarmed state and flashes when a zone becomes unsealed during the disarmed state. The indicator stops flashing when all zones are sealed.

### 4.7 On Indicator/Zone In Alarm



The **ON** indicator displays when the system is armed in AWAY Mode and flashes when an alarm occurs. The indicator resets once a valid user code is entered.

### 4.8 FAULT Indicator



The FAULT indicator displays the system detected a system fault. See *Section 12. Fault Analysis Mode* for additional information on system faults.

Every time a new system fault is detected (such as, FAULT indicator flashing), the codepad beeps once every minute. Pressing the [#] button once cancels the once a minute beep and acknowledges the fault (such as, FAULT indicator on steady).

**Table 6: FAULT Indicator**

FAULT Indicator	Definition
On	There is a system fault that must be rectified.
Off	The system is normal, there are no faults.
Flashing	There is a system fault that must be acknowledged.

### 4.9 Audible Indications

*Table 7* defines the audible indicators generated by the codepad buzzer.

**Table 7: Audible Indicators**

Audible Indicator	Definition
One short beep	A button was pressed on the codepad, or end of exit time when armed in STAY Mode 1 or STAY Mode 2.
Two short beeps	The system accepted your code.
Three short beeps	The requested function was executed.
One long beep	Indicates the end of exit time when armed in AWAY Mode, or the requested operation was denied or aborted.
One beep every second	Walk Test Mode is currently active or warning before automatic arming takes place.
One short beep every minute	There is a system fault waiting to be acknowledged.

## 5. Arming the System

There are several ways to arm the system depending on whether you are:

- Leaving the premises and require all active zones to be in a ready state for an intruder.
- Remaining in the premises and only require part of the system to be in a ready state for an intruder.

If a zone is not sealed at the end of exit time, the zone is automatically isolated and constantly displays on the remote codepad. The zone becomes an active part of the system when the zone reseals. For example, if a window is left open after exit time expires, the window is not an active part of the system until the window is closed. Opening the window after exit time expired causes an alarm condition.

*Table 8* defines the different methods for arming the system.

**Table 8: Arming Methods**

<b>AWAY Mode</b>	Arms the entire system. See <i>Section 5.1 Arming in AWAY Mode</i> .
<b>STAY Mode 1</b>	Arms all zones except those programmed to be automatically isolated by the installer. See <i>Section 5.2 Arming in STAY Mode 1</i> .
<b>STAY Mode 2</b>	Arms all zones except those programmed to be automatically isolated by the Master Code holder. See <i>Section 5.3 Arming in STAY Mode 2</i> .

## Forced Arming

The feature of arming the system when a zone is not sealed is known as forced arming. If the system does not arm and a long beep is heard, forced arming is not permitted. If this is the case, ensure that all zones are sealed or manually isolated before arming the system.

### 5.1 Arming in AWAY Mode

When you leave your premises and require all zones to be in a ready state to detect intrusion, you arm the system in AWAY Mode. When returning to your premises, disarm your system (see *Section 6. Disarming the System*) so you do not sound a false alarm.

There are two different methods for arming the system in AWAY Mode. Method one is standard and always operates. Method two is optional and may be disabled by your installer if you do not want to use single button arming.

#### Arming in AWAY Mode, Method 1

Enter your user code followed by the [#] key (for example, [2 5 8 0 #]). Two beeps sound and the AWAY indicator displays. Exit time starts counting.

#### Arming in AWAY Mode, Method 2

Hold down the [#] key until two beeps sound. The AWAY indicator displays and exit time starts counting.

### 5.2 Arming in STAY Mode 1

STAY Mode 1 is only used when the perimeter and unused areas of the premises must be armed to detect if an intruder is entering the premises. At the same time it allows you to move freely within an area that is automatically isolated.



Only your security company can program zones automatically isolated in STAY Mode 1.

There are two different methods for arming the system in STAY Mode 1. Method one is standard and always operates. Method two is optional and may be disabled by your installer if you do not want to use single button arming.

#### Entry Guard Timer for STAY Mode 1

When arming the system in STAY Mode 1, an optional entry timer called Entry Guard Timer For STAY Mode 1 is available. Use this entry timer to delay the sirens if a zone is not automatically isolated and triggers an alarm condition. Entry Guard Timer For STAY Mode 1 is the delay time used for all zones except 24-hour zones when the system is armed in STAY Mode 1 or STAY Mode 2.

If the Entry Guard Timer For STAY Mode 1 is programmed and a zone not automatically isolated is triggered, the codepad beeps twice per second until the entry timer expires or the system disarms. If the alarm condition is not reset by entering your user code followed by the [#] key (for example, [2 5 8 0 #]) before the entry timer expires, the sirens activate into alarm. Only your installer can program this feature.

#### Arming in STAY Mode 1, Method 1

Enter your user code followed by the [\*] key (for example, [2 5 8 0 \*]). Two beeps sound and the STAY indicator displays. Exit time starts counting.

Any zones programmed to be automatically isolated in STAY Mode 1 flash until exit time expires. At the end of exit time, all zones selected to be automatically isolated turn off and the codepad gives one short beep.

#### Arming in STAY Mode 1, Method 2

Hold down the [\*] button until two beeps are heard. The STAY indicator displays and exit time starts counting.

Any zones programmed to be automatically isolated in STAY Mode 1 flash until exit time expires. At the end of exit time, the zone indicators turn off and the codepad emits one short beep.

### 5.3 Arming in STAY Mode 2

STAY Mode 2 is only used when the perimeter and unused areas of the premises must be armed to detect an intruder from entering the premises while you move freely within an area that is automatically isolated. Any Master Code user can program zones to be automatically isolated in STAY Mode 2.

#### Entry Guard Timer For STAY Mode 2

When arming the system in STAY Mode 2, an optional entry timer called Entry Guard Timer For STAY Mode 2 is available. Use this entry timer to delay the sirens if a zone is not automatically isolated and triggered into alarm condition. Entry Guard Timer for STAY Mode 2 is the delay time used for all zones except 24-hour zones when the system is armed in STAY Mode 1 or STAY Mode 2.

If the Entry Guard Timer For STAY Mode 2 is programmed and a zone not automatically isolated triggers, the codepad beeps twice a second until the entry timer expires or the system disarms. If the alarm condition is not reset by entering your user code followed by the [#] button (for example, [2 5 8 0 #]) before the entry timer expires, the sirens activate into alarm. Only your installer can program this option.



## Arming in STAY Mode 2

Hold down the [0] button until two beeps sound. The STAY indicator lights and exit time starts counting.

Any zones programmed to be automatically isolated in STAY Mode 2 flash until exit time expires. At the end of exit time, all zones selected to be automatically isolated extinguish and the codepad provides one short beep.

## 5.4 Programming STAY Mode 2 Zones

You can only program zones to be automatically isolated in STAY Mode 2 if you have a Master Code.

### How to Program STAY Mode 2 Zones

1. Enter your four-character Master Code, followed by the [4] and [#] keys (for example, [2 5 8 0 4 #]). Three beeps sound and the STAY indicator flashes.
2. Enter the zone number to be automatically isolated, followed by the [\*] key (for example, [1 \*] = Zone 1, [2 \*] = Zone 2). The selected zone flashes. If you make a mistake, enter the same zone number followed by the [#] key to clear the incorrect zone. To select additional zones to be automatically isolated in STAY Mode 2, repeat Step 2 as many times as required.
3. To exit this mode, press the [#] key when you have selected all zones to be automatically isolated in STAY Mode 2. Two beeps sound and the STAY and AWAY indicators turn dark.

## 6. Disarming the System

When you enter the premises after the system is armed in AWAY Mode, or if you have armed the system in STAY Mode 1 or STAY Mode 2, you must disarm the system before entry time expires to disable detection devices that activate an alarm. Only your installer can program the entry time.

If there was an alarm condition prior to disarming the system, a flashing zone indicator displays indicating a previous alarm on that zone.

### How to Disarm the System

Enter your user code followed by the [#] key (for example, [2 5 8 0 #]). Two beeps sound.

## 7. User Codes

### 7.1 Adding User Codes

Only the Master Code holder can add or change other system user codes, including the Master Code. Up to eight user codes can be programmed to operate the system.

### How to Add a User Code

1. Enter your four-character Master Code, followed by [1] and [#] (for example, [2 5 8 0 1 #]). Three beeps sound and the STAY and AWAY indicators flash.
2. Enter the user code number (1 to 8) followed by the [#] key (for example, [2 #] = User 2, [8 #] = User 8). Two beeps sound and the selected user number displays on the codepad indicators.
3. Enter the digits required for the new code followed by the [#] key (for example, for user code 5768, enter [5 7 6 8 #]). Two beeps sound and the STAY and AWAY indicators turn dark. To add or change other user codes, repeat this procedure as many times as required.

### 7.2 Adding Radio Remote User Codes

Only the Master Code holder can add or change other system user codes, including the Master Code. Up to eight radio user codes (User Codes 9 to 16) can be programmed to operate the system.

#### How to Add a Radio Remote User Code

1. Enter your four-character Master Code, followed by the [1] and [#] keys (for example, [2 5 8 0 1 #]). Three beeps sound and the STAY and AWAY indicators flash.
2. Enter the radio remote user code number (9 to 16), followed by the [#] key (for example, [9 #] = User 9, [1 6 #] = User 16). Two beeps sound and the selected user number displays on the codepad indicators.
3. Press any button on the keyfob so the system learns the ID number. Two beeps sound and the STAY and AWAY indicators extinguish. To add or change other radio remote user codes, repeat this procedure as many times as required.

### 7.3 Deleting User Codes/Radio User Codes

Only the Master Code holder can delete other system user codes.

#### How to Delete a User Code

1. Enter your four-character Master Code, followed by the [1] and [#] keys (for example, [2 5 8 0 1 #]). Three beeps sound and the STAY and AWAY indicators flash.
2. Enter the user code number (User Code 1 to 8, Radio User Code 9 to 16), followed by the [#] key (for example, [2 #] = User 2, [1 6 #] = User 16). Two beeps sound and the selected user number displays on the codepad indicators.
3. Press the [\*] key to delete the selected user code. Two beeps sound and the STAY and AWAY indicators turn dark. To delete other user codes, repeat this procedure as many times as required.

## 8. Radio Transmitter Operations

**Figure 3: RE012/E – 2 Channel Keyfob Transmitter**

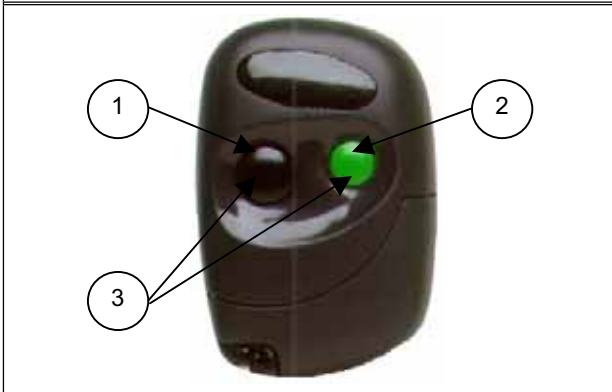

- 1 – Button 1: Arm or disarm in AWAY Mode
- 2 – Button 2: Arm or disarm STAY Mode
- 3 – Buttons 1 and 2: Press both buttons at same time to activate Panic alarm.

**Figure 4: RE013/E – 4 Channel Keyfob Transmitter**

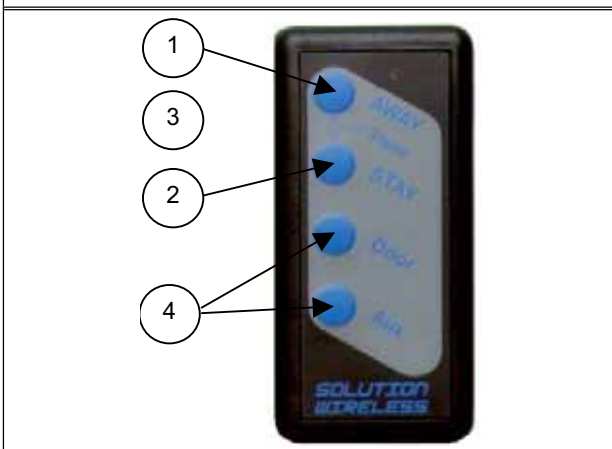

- 1 – Button 1: Arm or disarm in AWAY Mode
- 2 – Button 2: Arm or disarm in STAY Mode
- 3 – Buttons 1 and 2: Press both buttons at same time to activate Panic alarm.
- 4 – Buttons 3 and 4: Your security company can program these buttons for optional operation, such as operating a garage door.

### Audible/Visual Indications

When using hand held keyfob transmitters to operate the system, your security company can program the keyfobs to sound the horn speaker or operate the blue strobe light. These indications allow you to operate the system from outside the premises with confidence.

**Table 9: Keyfob Audible/Visual Indications**

Indication	Definition
One beep	System disarmed.
Two beeps	System armed in AWAY Mode.
Two-tone beep	System armed in STAY Mode.
3-second strobe	System disarmed.
6-second strobe	System armed in AWAY or STAY Mode.

## 9. Alarms

### 9.1 Duress Alarm

A codepad duress alarm is used as a silent hold-up alarm. This only occurs when the number 9 is added to the end of any valid user code used to disarm the system (for example, [2 5 8 0 9 #]). A duress alarm is only useful if your system reports back to a monitoring station or pocket pager, because domestic reporting (such as a mobile phone) cannot decipher which type of alarm occurred.

**Figure 5: CP5 LED Codepad Showing Audible Alarm Buttons**

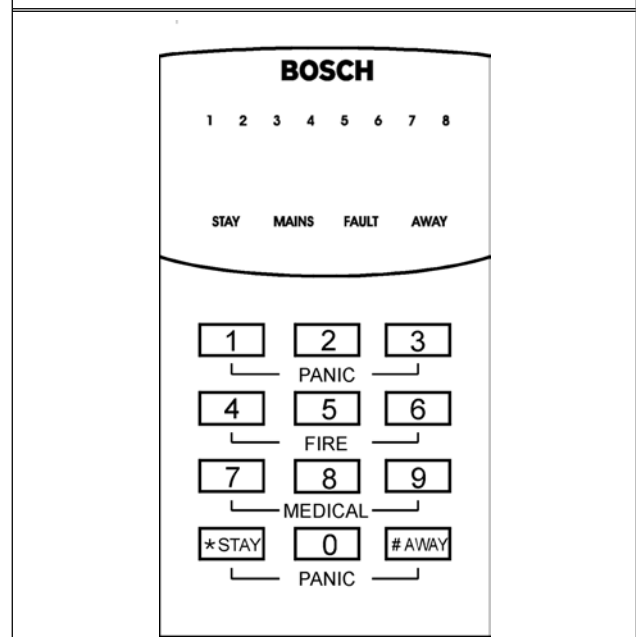

### 9.2 Panic Alarm

An audible alarm activates when the [1] and [3] keys or the [\*] and [#] keys are pressed simultaneously. Contact your installer to disable the ability to activate the codepad panic alarm or to silence the codepad panic alarm.

### 9.3 Fire Alarm

The horn speaker emits a distinct fire sound when both the [4] and [6] keys are pressed simultaneously. Contact your installer to disable the ability to activate the codepad fire alarm or to silence the codepad fire alarm.

### 9.4 Medical Alarm

An audible alarm activates when both the [7] and [9] keys are pressed simultaneously. Contact your installer to disable the ability to activate the codepad medical alarm or to silence codepad medical alarm.

### 9.5 Tamper Alarm (Access Denied)

The tamper alarm restricts the number of times an invalid user code can be used in an attempt to operate the system. When the number of incorrect code attempts equals the number programmed by your installer, the system activates an alarm condition. If reporting back to a security monitoring station, the system sends an Access Denied Report.

To shutdown and lockout a codepad for a period of time (0 to 150 seconds), ask your installer to program this feature.

## 10. Isolating Zones

Isolating zones allow you to manually disable one or more zones before arming the system. Once a zone is isolated, you can access that zone during the armed state without activating an alarm.

For example, you may need to isolate a zone because before arming the system a PIR detector might generate a false alarm, or you need to leave a pet inside a particular zone while away.

Isolating zones is performed by one of two methods. Method two is optional and only allows those user codes programmed by your installer access to isolate zones.

### 10.1 Standard Isolating

Standard Isolating allows all operators to isolate zones without knowing a valid user code.

#### How to Isolate a Zone

1. Press the [\*] key twice to enter Isolating Mode. Three beeps sound and the STAY indicator flashes.
2. Enter the zone number (1 to 8), followed by the [\*] key (for example, [1 \*] = Zone 1, [2 \*] = Zone 2).

Each zone to isolate has a corresponding zone indicator that flashes. If you selected an incorrect zone to isolate, enter the incorrect zone number again followed by the [\*] key.

Repeat Step 2 if you are isolating more than one zone, until all zones to isolate are selected.

3. Press the [#] key after all selected zones are isolated. Two beeps sound and the system returns to the disarmed state.

### 10.2 Code to Isolate

Only those user codes with the Code to Isolate priority level can isolate zones. If any user code has this priority level, the standard isolating method (see *Section 10.1 Standard Isolating*) does not function.

#### How to Isolate a Zone

1. Press the [\*] key followed by your user code and the [\*] key again to enter Isolating Mode (for example, [\* 2 5 8 0 \*]). Three beeps sound and the STAY indicator flashes.
2. Enter the zone number (1 to 8), followed by the [\*] key (for example, [1 \*] = Zone 1, [2 \*] = Zone 2). Each zone to isolate has a corresponding zone indicator that flashes. If you selected an incorrect zone to isolate, enter the incorrect zone number again followed by the [\*] key. Repeat Step 2, if isolating more than one zone, until all zones to isolate are selected.
3. Press the [#] key after all selected zones are isolated. Two beeps sound and the system returns to the disarmed state.

## 11. Setting the Date and Time

Programming the date and time is only required when you need functions such as automatic test reports, automatic arming, and history events to operate correctly.

#### How to Program Date and Time

1. Enter your Master Code followed by the [6] and [#] keys (for example, [2 5 8 0 6 #]). Three beeps sound and the STAY and AWAY indicators flash.
2. Enter the day, month, year, hour, and minute using the (DD, MM, YY, HH, MM) format (that is, DD = day of the month, MM = month of the year, YY = current year, HH = hour of the day, MM = minute of the day).



When programming the hour of the day, you must use a 24-hour format.

3. Press the [#] key to exit and return to the disarmed state. Two beeps sound and the STAY and AWAY indicators go dark. If a long beep sounds, an error was made when entering the date and time.

## 12. Fault Analysis Mode

If a fault occurs, the FAULT or MAINS indicators flash and the codepad beeps once every minute.

### 12.1 AC Fail

If the AC mains supply fails, the MAINS indicator flashes until the AC mains supply is restored. Pressing the [#] key once acknowledges the fault and stops the codepad from beeping once every minute.

### 12.2 System Faults

#### How to Determine the Type of System Fault

To determine all system faults other than the AC mains supply, enter Fault Analysis Mode:

1. Hold down the [5] key until two beeps sound. The FAULT indicator lights steadily and the STAY and AWAY indicators flash in unison. Any zone indicators displayed indicate the type of fault that occurred. See *Table 10* for the list of system faults that can occur.
2. To further determine the type of fault condition, hold down the key that corresponds to the zone indicator displayed.
3. To exit Fault Analysis Mode and return to the disarmed state, press the [#] key. The FAULT indicator remains displayed and the codepad stops beeping once per minute.

### 12.3 Fault Descriptions

**Table 10: Fault Condition Indicators**

Zone LED	FAULT Condition
1	Battery Fail
2	Date/Time
3	Sensor Watch
4	Horn Speaker Fail
5	Telephone Line Fail
6	E2 Fault
7	Fuse Fail
8	Communication Fail

#### Battery Fail

A battery fail fault registers when the system detects a low capacity back-up battery. The system automatically performs a Battery Test every 4 hours and every time the system is armed.

#### Date and Time

The date and time fault registers every time the system powers down. This type of fault does not cause the FAULT indicator to display on the codepad unless your installer has programmed the automatic arming time. See *Section 11. Setting the Date and Time* to program the date and time.

#### Sensor Watch Fail

A sensor watch fault registers because one or more detection devices failed to notice any movement during the disarmed state for the time period programmed by your installer. The fault clears when the zone in question detects movement and resets.

While in Fault Analysis Mode, hold down the [5] key until two beeps sound. The indicator lights that corresponds to the faulted zone.

#### Horn Speaker Fail

A horn speaker failure fault registers when the system detects the horn speaker is disconnected. This fault clears once the horn speaker is reconnected. Your installer needs to program the system for this feature to operate.

#### Telephone Line Fail

A telephone line failure fault registers when the system detects the telephone line is disconnected from the control panel. Your installer needs to program the system for this feature to operate.

#### E2 Fault

An E2 failure fault registers when the system detects an internal checksum error. Contact your installer as soon as this fault displays.

#### Fuse Fail

A fuse failure fault occurs when either of the two 1 A fuses are blown. Contact your installer as soon as this fault displays.

#### Communication Fail

A communication fail fault registers when the control panel fails to communicate with the receiving party (for example, a monitoring company, mobile phone, pocket pager, and so on). The communication fault clears once the control panel successfully reports to the receiving party.

## 13. Telco Arm/Disarm Sequence (Call Forward On/Off)

Use this feature to program the Telco Arm Sequence and Telco Disarm Sequence (Call Forward On/Off).

### 13.1 Telco Arm Sequence

Use this to program the Call Forward – Immediate On sequence or Call Forward – No Answer sequence to automatically operate when you arm the system in AWAY Mode. This feature is only available if your telecommunications provider has the call-forward option.



The examples given in this feature are only applicable to Australia.

#### Call Forward – Immediate On

You can redirect calls to anywhere in Australia, including mobile phones, pagers, and answering services. When Call Forward is turned on, your telephone does not ring.

#### Call Forward – No Answer

When your telephone is not answered within 20 seconds, this feature redirects all incoming calls to another number anywhere in Australia, but you can still make outgoing calls.

**Table 11: Telco Arm/Disarm Dialing Digits**

Digit Required	Number to Program	Digit Required	Number to Program
0	0	8	8
1	1	9	9
2	2		
3	3	*	*1
4	4	#	*2
5	5	4-sec pause	*3
6	6	break	*4
7	7		

#### How to Program the Telco Arm Sequence

1. Enter your four-character Master Code, followed by the [3] and [#] keys (for example, [2 5 8 0 3 #]).  
Three beeps sound and the STAY and AWAY indicators flash.
2. Press button [1] and [#] keys to select the Telco Arm Sequence.  
Three beeps sound.

3. Enter the call forward sequence (for example, [\* 6 1][Phone Number][#] to program the Call Forward - No Answer sequence, or [\* 2 1][Phone Number][#] to program the Call Forward Immediate sequence).  
To program a “\*” in the Telco Arm Sequence, enter [\* 1]. To program a “#” in the Telco Arm Sequence, enter [\* 2].
4. Press the [#] key when finished.  
Two beeps sound, and the STAY and AWAY indicators go dark.



To disable the Telco Arm Sequence, enter the call forward sequence as [\* 4] (break) for Step 3.

### 13.2 Telco Disarm Sequence

This feature automatically disables the call forward sequence when disarming the system.

#### How to Program the Telco Disarm Sequence

1. Enter your four-character Master Code followed by the [3] and [#] keys (for example, [2 5 8 0 3 #]).  
Three beeps sound and the STAY and AWAY indicators flash.
2. Press the [2] and [#] key to select the Telco Disarm Sequence. Three beeps sound.
3. Enter the call forward disable sequence (for example, [# 6 1 #] to disable the No Answer Call Forward sequence, or [# 2 1 #] to disable the Call Forward Immediate sequence).  
To program a “#” in the Telco Disarm Sequence, enter [\* 2].
4. Press the [#] key when finished.  
Two beeps sound, and the STAY and AWAY indicators go dark.



To disable the Telco Disarm Sequence, enter the call forward sequence as [\* 4] (break) for Step 3.

## 14. Turning Outputs On/Off

This feature only applies if your installer set up an output that can be turned on or off by the codepad. The output programmed by your installer can control a pool pump, outside lighting, and so on. Up to three separate outputs may be programmed.

### How to Turn an Output On or Off

1. Enter your Master Code followed by the [5] and [#] keys (for example, [2 5 8 0 5 #]). Three beeps sound and the STAY and AWAY indicators flash.
2. Enter the output number (1 to 3) that you wish to turn on or off.
3. Press the [#] key to turn the output on, or press the [\*] key to turn the output off. Three beeps sound if the output is turned on, and two beeps sound if the output is turned off. Repeat Step 2 and Step 3 if you require more than one output to be turned on or off.
4. Press the [#] key to exit this function. Two beeps sound and the STAY and AWAY indicators go dark.

## 15. Reset Latching Outputs

This feature only applies if your installer programmed an output to latch (remain on) until you acknowledge the event that occurred.

### How To Reset Latching Outputs

Hold down the [7] key until two beeps sound. The output resets.

## 16. Codepad ID/Buzzer Tone Change

Hold down the [8] key continuously to change the tone of the codepad buzzer. There are 50 different tones, from 1500 Hz to 5000 Hz. If multiple codepads are installed, each codepad can sound a different tone.

If the system is partitioned, the keypad first displays the area to which the keypad is assigned:

- Zone 1: Area 1 codepad
- Zone 2: Area 2 codepad
- Zone 7: master partitioned codepad

## 17. Testing

There are various functions for testing that your system is operating correctly.

### 17.1 Horn Speaker Test

Press and hold the [1] key until two beeps sound. The horn speaker sounds for 2 seconds.

### 17.2 Bell Test

Press and hold the [2] key until two beeps sound. The bell output operates for 2 seconds.

### 17.3 Strobe Test

1. Press and hold the [3] key until three beeps sound. The strobe flashes.
2. Press and hold the [3] key until two beeps sound. The strobe stops flashing.

### 17.4 Walk Test Mode

Use Walk Test Mode to test detection devices for proper operation. Every time you test a zone, the codepad sounds one long beep and the horn speaker sounds one short beep to indicate the zone was activated when testing.

1. Enter your four-character Master Code, followed by the [7] and [#] keys (for example, [2 5 8 0 7 #]). Three beeps sound, and the STAY and AWAY indicators flash. The codepad beeps once every second while the system is in Walk Test Mode.
2. Activate all zones that require testing. The codepad sounds one long beep and the horn speaker sounds one short beep every time a zone is faulted (unsealed) and restored.
3. When you finish testing all required zones, press the [#] key to exit this mode. Two beeps sound, and the STAY and AWAY indicators turn off. The system returns to the disarmed state.

### 17.5 Test Report

This feature only applies if your system reports by telephone. Press and hold the [9] key until two beeps sound. The system sends a Test Report without sounding the sirens.

## 18. Event Memory Recall

Use this function to replay the last 40 events that occurred to the system. The event memory history replays all alarms and arming/disarming of the system in AWAY Mode, STAY Mode 1, and STAY Mode 2.



The system cannot differentiate between arming the system in STAY Mode 1 or STAY Mode 2.

### How to Enter Event Memory

Enter your four-character Master Code followed by the [8] and [#] keys (for example, [2 5 8 0 8 #]). Three beeps sound. The last 40 events display one at a time by the codepad indicators, starting from the most recent event. A beep sounds as each event displays.

## 19. Day Alarm

Day alarm allows a combination of zones to be monitored during the disarmed state by beeping the codepad buzzer. Only your installer can program zones 1 to 4 to operate for day alarm.

### Example

A day alarm can be set up at the front door of a shop with a pressure mat or electronic beam that customers activate as they enter and exit the shop. As the customers walk onto the pressure mat or break the electronic beam, the codepad buzzer beeps.

### How to Turn Day Alarm On

Hold down the [4] key until three beeps sound. Day alarm turns on. All zones programmed for day alarm operation cause the codepad buzzer to beep during the disarmed state when activated.

### How to Turn Day Alarm Off

Hold down the [4] key until two beeps sound. Day alarm turns off.

## 20. Remote Arming By Telephone

Use this feature to arm your system from any remote location using a telephone. For security reasons, the system cannot be disarmed using this method. This feature requires a touch-tone telephone. Your installer must program this feature to operate.

### How to Remotely Arm your System Using the Telephone

1. Call the telephone number connected to your control panel.
2. When the control panel answers the incoming call, a short jingle is heard. To arm the system, press the [\*] key on the touch-tone telephone for 1 to 3 seconds.  
If you hear modem tones when the control panel answers the incoming call, the system was programmed for remote programming functions by your installer. Wait for a pause between the tones before pressing the [\*] key.  
After releasing the [\*] key on the touch-tone telephone, two beeps sound indicating that the system was armed in AWAY Mode.
3. Hang up the telephone and the system remains armed.



If your installer programs answering machine bypass, you must call the control panel twice to make a connection with the system. For example, call the telephone number that your control panel is connected to, let the call ring no more than four rings, then hang up the telephone. Wait a minimum of 8 seconds before you call the control panel again.

## 21. Domestic Dialling

Domestic dialling is used to call your mobile phone or a relative/friend in the event your control panel activates an alarm. Up to three different telephone numbers can be programmed for the control panel to call when an alarm occurs. Only your installer can set the system to report in the domestic format, however, the Master Code holder can change the domestic telephone numbers at any time.

### 21.1 Acknowledging Domestic Calls

When an alarm condition occurs, the system calls the first telephone number that was programmed. When you answer an incoming call, you hear the system sound a repeating siren tone followed by a pause, continually for 2 minutes (for example, siren tone, pause, siren tone, and pause).

If you do not acknowledge the call from the control panel during a pause between siren tones, the control panel hangs up after 2 minutes expire, and calls the next telephone number.

Pressing the [\*] key for 1 to 3 seconds during the pause acknowledges the call and no further calls are made for that event. If the call is successfully acknowledged, a tone of decreasing pitch is heard.

**Table 12: Domestic Dialling Telephone Digits**

Digit Required	Number to Program	Digit Required	Number to Program
0	0	8	8
1	1	9	9
2	2		
3	3	*	*1
4	4	#	*2
5	5	4-sec. pause	*3
6	6	break	*4
7	7		

### 21.2 Programming Domestic Telephone Numbers

If your system is configured for domestic dialling, this function allows any Master Code holder to program telephone numbers the control panel calls in the event of an alarm.

### How to Program Telephone Numbers

1. Enter your four-character Master Code, followed by the [2] and [#] keys (for example, [2 5 8 0 2 #]). Three beeps sound and the STAY and AWAY indicators flash. If there are telephone numbers already programmed, they are displayed one digit at a time by the codepad indicators. If there are no telephone numbers programmed, a further two beeps sound after entering this mode. These two beeps are normally heard after the last digit of the last telephone number displays.
2. Enter all digits for the first telephone number (for example, [9 6 7 2 1 7 1 7]). As each digit is entered, the corresponding codepad indicators display.
3. If there is more than one telephone number to be programmed, press [\* 4]. This inserts a break between the first telephone number and the second telephone number. If there is only one telephone number to program, press the [#] key to exit this function.
4. Enter all the digits of the second telephone number (for example, [9 6 7 2 1 0 5 5]). As each digit is entered, the corresponding codepad indicators display.
5. After the last digit of the second telephone number is programmed, press the [#] key to exit this function unless a third telephone number is required. If there is a third telephone number to program, press the [\* 4] button to insert a break between the second telephone number and the third telephone number.

### 21.3 Disable Domestic Dialling

To cancel domestic dialling (for example, you are moving and do not want the system to continue calling your mobile phone), enter the following sequence.

1. Enter your four-character Master Code, followed by the [2] and [#] keys (for example, [2 5 8 0 2 #]). Two beeps sound and the STAY and AWAY indicators flash.
2. Press the [\*] button followed by the [4] and [#] keys (for example, [\* 4 #]). The STAY and AWAY indicators go dark.



## 22. Partitioning

You can partition or split the Solution 880 Control Panel into two individual areas. You can operate both areas from one Master Partitioned codepad or from separate area addressable codepads.

### 22.1 Master Partitioned Codepad Indicators

Figure 6: Master Partitioned Codepad

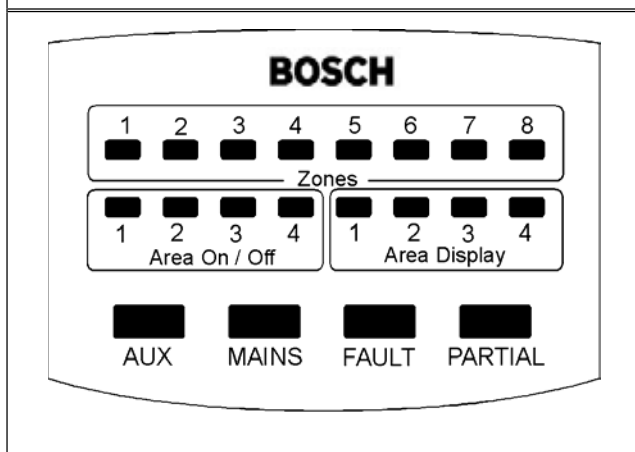

The indicators on a Master Partitioned codepad are configured into four groups. The following paragraphs describe the indicators.

#### 22.1.1 Zone Indicators

The zone indicators (1 to 8) display the status of each zone. These zones belong to the area whose AREA DISPLAY indicator is lit. If a ZONE indicator is lit, that zone is unsealed. If a ZONE indicator is not lit, that zone is sealed.

#### 22.1.2 Area On/Off Indicators

The group of four AREA ON/OFF DISPLAY indicators show the status of each area. If an indicator is lit, that area is armed. If the indicator is not lit, that area is disarmed.

#### 22.1.3 Area Display Indicators

A group of four AREA DISPLAY indicators determine the area to which the displayed zones belong.

#### 22.1.4 Status Indicators

This group of four indicators shows the following:

##### AUX Indicator

The AUX indicator displays when the system is using the telephone line to communicate to the receiving party.

The AUX indicator flashes in conjunction with the PARTIAL indicator to show successful entry into any programming mode. For example, this occurs when you are using Master Code functions.

##### Mains Indicator

This indicator displays the status of the AC mains supply. The indicator lights steadily when the AC is normal and flashes when there is an AC supply failure.

##### Fault Indicator

This indicator displays the status of the system's fault register. If the FAULT indicator flashes when the system detects a fault that has not yet been acknowledged. If the indicator lights steadily, the fault has been acknowledged.

##### Partial Indicator

This indicator shows whether an area is armed in STAY Mode 1. If the PARTIAL indicator is lit, the area is armed in STAY Mode 1. If the indicator is not lit, no areas are armed in STAY Mode 1. When isolating zones, the PARTIAL indicator flashes to indicate that you are in the isolate mode. The PARTIAL indicator also flashes in conjunction with the AUX indicator to indicate successful entry into any programming mode (for example, when using Master Code functions).

### 22.2 Operating From A Master Partitioned Codepad

If you have a partitioned system with a Master Partitioned codepad installed, operating procedures described throughout this guide are the same with one exception. All operations are relative to the area whose AREA DISPLAY indicator is illuminated at the time.

#### Example

When the AREA DISPLAY indicator number 2 is lit, all operations performed affect only Area 2. To perform operations in another area, you must move the AREA DISPLAY illuminator to the desired area.

#### To Move From One Area To The Next

Press the AWAY button.

The area display indicator moves to the next area. Repeat until the desired indicator is lit.

### 22.3 Operating From Area Addressable Codepads

If you have a partitioned system with Area Addressable codepads, the operating procedures described throughout this guide are the same. Refer to 16. *Codepad ID/Buzzer Tone Change* on page 14 to determine the area to which a particular codepad belongs.

## 23. Basic Pager Reporting

This feature only applies if your system reports to a pocket pager. Basic pager reporting requires some interpretation of the numbers that appear on the display. It is possible to differentiate between 1000 different systems when a number of control panels report to the one pocket pager.

### Subscriber ID Number

This is the identification number of the control panel and can only be programmed by your installer.

### Zone Status

The zone status display shows you the status of each zone (1 to 8). *Table 13* describes what each number means when displayed on the zone status display.

**Table 13: Zone Status Display Descriptions**

Number Displayed	Zone Description
0	Zone Normal Indicates the corresponding zone is in the sealed state.
1	Alarm Indicates the corresponding zone is unsealed and in alarm condition.
2	Zone Bypassed Indicates a system operator manually isolated the corresponding zone. See <i>Section 10. Isolating Zones</i> for information on how to manually isolate a zone(s) prior to arming the system.
3	Zone Trouble Indicates a zone was left unsealed after the end of exit time.

### System Status

The system status information is divided into the four digits identified in *Table 14*.

**Table 14: System Status**

System Status Display	Description
First digit	Indicates whether the system is armed or disarmed: 8 = Disarmed 9 = Armed
Second digit	Indicates which codepad alarm was triggered by the operator: 0 = No Codepad Alarm 1 = Codepad Panic or Duress Alarm 2 = Codepad Fire Alarm 3 = Codepad Medical Alarm
Third digit	Indicates when the AC mains supply fails: 0 = AC Supply is normal 1 = AC Supply failed
Fourth digit	Indicates when a system fault occurs at the control panel: 0 = System Normal – There are no faults. 1 = System Fault – There is a fault registered by the control panel.

*Figure 7* shows the transmission came from the control panel with an ID number of 678, and zone 2 is in alarm. *Figure 7* also displays zone 3 is manually isolated and the system is armed.

Figure 7: Basic Pager Display

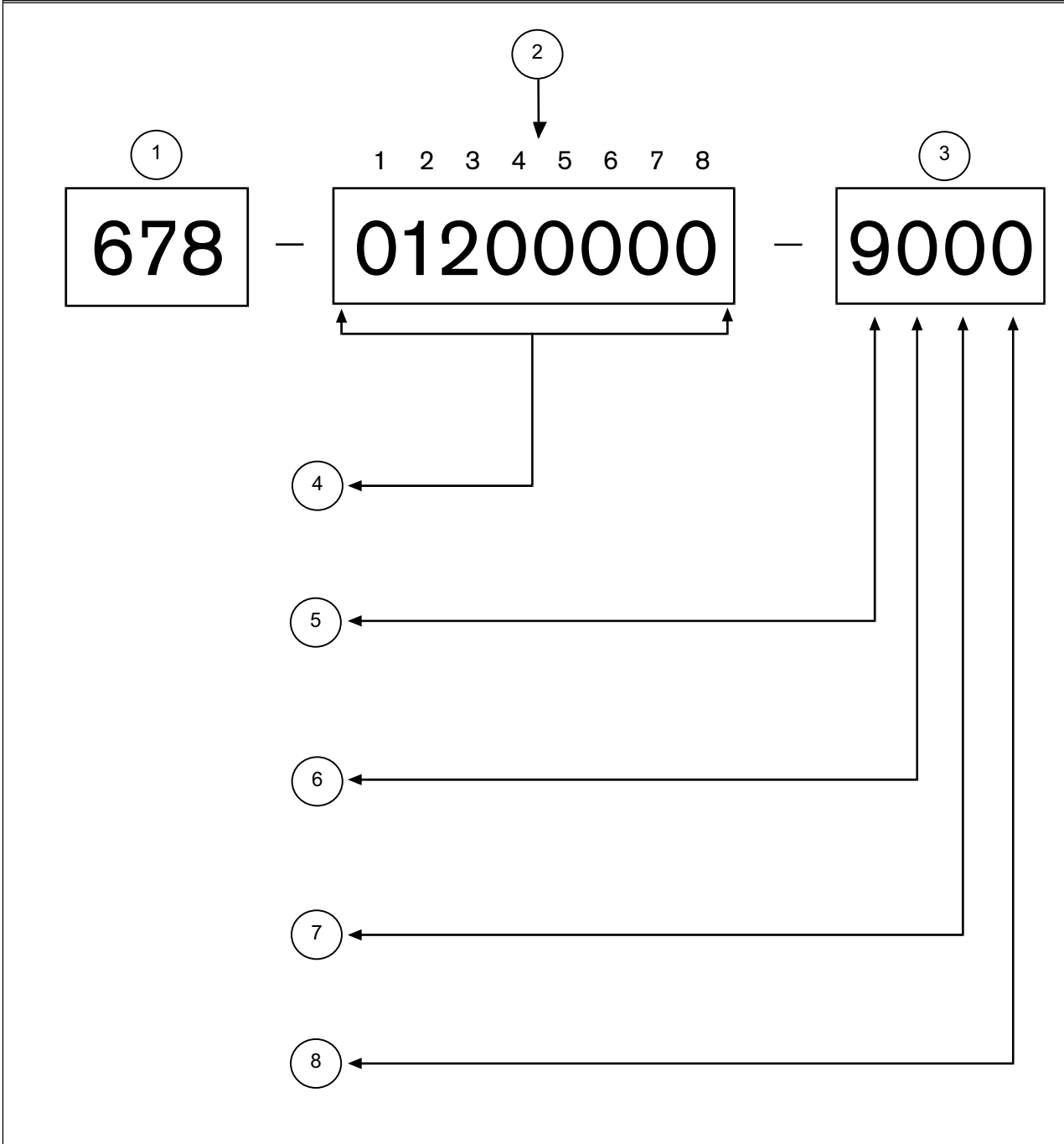

- 1 – Subscriber ID number
- 2 – Zone status
- 3 – System status
- 4 – 0: Zone Normal  
1: Alarm  
2: Zone Bypassed  
3: Zone Trouble
- 5 – 8: Disarmed  
9: Armed

- 6 – 0: Normal  
1: Panic/Duress  
2: Fire Alarm  
3: Medical Alar
- 7 – 0: AC Normal  
1: AC Failure
- 8 – 0: System Normal  
1: System Fault

## 24. Glossary of Terms

**Table 15: Glossary of Terms**

Term	Description
24-Hour Zones	A monitored input programmed to trigger an alarm condition when violated when the system is armed or disarmed 24 hours a day.
Alarm Condition	Your alarm system is armed and one of the detection devices is violated. A 24-hour zone (such as a smoke detector) can activate an alarm condition when your system arms or disarms.
Answering Machine Bypass	Answering machine bypass is incorporated. You can connect to the system for remote arming operations when there is an answering machine or facsimile machine on the same telephone line.
Armed	The system is in a ready state to accept alarms.
Automatic Arming	The system automatically arms at the same time every day in AWAY Mode or STAY Mode 1.
Automatic Disarming	The system automatically disarms at the same time every day.
AWAY Mode	Used to arm your system when you leave your premises.
Codepad	Arm/disarm the system and carry out other functions such as adding and deleting system user codes.
Day Alarm	Monitor a combination of zones while the system is disarmed.
Detectors	Devices connected to your alarm system used to detect intrusion and cause an alarm condition. Some forms of detection devices include Passive Infrared (PIR), smoke detectors, photoelectric beams, reed switches, and vibration sensors.
Disarmed	A state that does not accept alarms except on zones programmed for 24-hour operation.
Dynamic Battery Testing	Used to monitor and test the condition of your back-up battery.
Entry Time/ Entry Delay	The time allowed by a zone for disarming the system after entering your premises.
External Equipment	Any device connected to your system such as detectors, codepads, and sirens.
Forced Arming	A situation where your alarm system can be armed when one or more zones are unsealed.
Handover Delay	The system is armed and a zone programmed for delay was violated. The delay zone hands over the remaining delay time to a zone programmed as handover. The handover zone does not activate an alarm until the remaining delay time expires. A handover zone acts as an instant zone if violated before the delay zone.
Hand Held Remote Control	Used to remotely operate your system by hand held transmitters.
Isolating	Manually disable (isolate) one or more zones before arming the system.
Master Code	A numeric code used to arm and disarm the system and to allow access to functions such as adding and deleting user codes.
Monitoring Station	A secure location where a digital receiver monitors numerous alarm systems and deciphers their Alarm Transmission Reports. The operator can then advise the appropriate authorities to take immediate action.
Panic Alarm	Type of alarm that indicates to the monitoring station there is an emergency situation at your premises.
Sealed	Refers to zone status. If a zone is sealed, the detection device is not violated and the zone indicator does not display on the codepad.
Sensor Watch	The control panel can recognise that detection devices may have stopped working or that the view to a PIR detector is blocked (unable to detect any movement over the duration of the time programmed by your installer).

Table 15: continued

Term	Description
Silent Alarm	Your installer may program zones for silent operation. When the zone programmed for silent operation is violated during the armed period, your alarm system communicates with the monitoring station without sounding the sirens.
STAY Mode 1	A condition that automatically isolates zones when your system is armed in STAY Mode 1. Only your installer can program zones to be isolated automatically in STAY Mode 1.
STAY Mode 2	A condition that automatically isolates zones when your system is armed in STAY Mode 2. Only the Master Code holder can program zones to be isolated automatically in STAY Mode 2.
Telco Arm Sequence	Telco arming is a feature that automatically calls the telephone exchange and diverts your telephone number to another telephone when the system is armed in AWAY Mode. (In Australia, this feature is called "Call Forward".)
Telco Disarm Sequence	Telco disarming automatically calls the telephone exchange and does not forward your telephone number.
Unsealed	Refers to zone status. A zone is unsealed when a zone is violated. The corresponding zone indicator displays on the codepad.
User Code	The personal identification number that the operator uses to arm and disarm the system.
Zones	A monitored input used to trigger an alarm condition when violated.

## 25. Installation Notes

Company Name	_____
Technician's Name	_____
Technician's Telephone Number	_____
Installation Date	_____
Warranty Expires	_____
Panel Software Version	_____

### Service Notes

---

---

---

---

---

---

---

---

---

---

---

---

---

---

---

---

---

---

---

---

---

---

---

### Zone Description

Describe each zone and mark the zones that are programmed to be automatically isolated in STAY Mode 1 or are programmed for day alarm operation.

		Isolated In STAY Mode 1	Day Alarm Enabled
Zone 1	_____	<input type="checkbox"/>	<input type="checkbox"/>
Zone 2	_____	<input type="checkbox"/>	<input type="checkbox"/>
Zone 3	_____	<input type="checkbox"/>	<input type="checkbox"/>
Zone 4	_____	<input type="checkbox"/>	<input type="checkbox"/>
Zone 5	_____	<input type="checkbox"/>	
Zone 6	_____	<input type="checkbox"/>	
Zone 7	_____	<input type="checkbox"/>	
Zone 8	_____	<input type="checkbox"/>	

### User Code Names

		Master Code	
Default = 2580	User Code 1 _____	<input checked="" type="checkbox"/> Y	User Code 9 _____
	User Code 2 _____	<input type="checkbox"/>	User Code 10 _____
	User Code 3 _____	<input type="checkbox"/>	User Code 11 _____
	User Code 4 _____	<input type="checkbox"/>	User Code 12 _____
	User Code 5 _____	<input type="checkbox"/>	User Code 13 _____
	User Code 6 _____	<input type="checkbox"/>	User Code 14 _____
	User Code 7 _____	<input type="checkbox"/>	User Code 15 _____
	User Code 8 _____	<input type="checkbox"/>	User Code 16 _____

### Entry/Exit Times

Entry Timer 1 \_\_\_\_\_ Exit Time \_\_\_\_\_  
 Entry Timer 2 \_\_\_\_\_ Entry Guard Time \_\_\_\_\_

### Arming Options

Single Button Arming  YES  NO      Forced Arming  YES  NO  
 Single Button Disarming  YES  NO      Remote Arming By Telephone  YES  NO  
 Automatic Arming (AWAY Mode)  YES  NO      Automatic Arming Time \_\_\_\_\_ AM/PM  
 Automatic Arming (STAY Mode)  YES  NO      Automatic Disarming Time \_\_\_\_\_ AM/PM

### Output Descriptions

Output 1 \_\_\_\_\_ Output 3 \_\_\_\_\_  
 Output 2 \_\_\_\_\_ Output 4 \_\_\_\_\_

### Isolating Method

Standard Isolating  YES  NO  
 Code To Isolate  YES  NO

### Communication Options

Back To Base Reporting  YES  NO  
 Domestic Reporting  YES  NO      Domestic Reporting – Number Of Beeps

### Other System Information

Siren Run Time  Minutes  
 Sensor Watch Time  Increments in Days

Can Your System Be Serviced By Another Technician  YES  NO      If Yes, Installer's Code \_\_\_\_\_



# Index

24-Hour Zones 20

## A

- AC Mains Fail 12
- Adding Radio User Codes 9
- Adding User Codes 9
- Alarm Condition 20
- Alarms
  - Duress ..... 10
  - Fire ..... 11
  - Medical ..... 11
  - Panic..... 10
  - Tamper (Access Denied)..... 11
- Answering Machine Bypass 20
- Area Display Indicators 17
- Area On/Off Indicators 17
- Armed 20
- Arming
  - AWAY Mode..... 8
  - STAY Mode 1..... 8
  - STAY Mode 2..... 8
  - Telephone Arming ..... 15
- Audible Indications 7
- Automatic Arming 20
- Automatic Disarming 20
- AUX Indicator 17
- AWAY Indicator 6
- AWAY Mode 8, 20

## B

- Battery Fail 12
- Battery Testing 20
- Bell Test 14

## C

- Codepad 20
  - Duress Alarm ..... 10
  - Fire Alarm ..... 11
  - Medical Alarm ..... 11
  - Panic Alarm..... 10
  - Tamper Alarm..... 11
- Codepad Indicators
  - Audible Indications ..... 7
  - AWAY Indicator ..... 6
  - FAULT Indicator ..... 7
  - MAINS Indicator..... 6
  - Off Indicator..... 7
  - On Indicator..... 7
  - STAY Indicator..... 6
  - System Disarmed ..... 6
  - Zone Indicators ..... 6
- Communciation Fail 12
- Communication Fail 12

## D

- Date and Time 12
- Day Alarm 15
- Deleting Radio User Codes 9
- Deleting User Codes 9
- Detectors 20
- Disarmed 20
- Disarming 9
- Domestic Dialling 16
  - Acknowledging Domestic Calls..... 16
  - Disable..... 16
  - Programming Domestic Telephone Numbers ... 16
- Duress Alarm 10

## E

- E2 Fault 12
- Entry Delay/Entry Time 20
- Entry Guard Timer 8
- Event Memory Recall 15
- External Equipment 20

## F

- Fault Analysis 12
- Fault Description
  - AC Mains Fail ..... 12
  - Battery Fail..... 12
  - Communication Fail ..... 12
  - Date and Time..... 12
  - E2 Fault ..... 12
  - Fuse Fail ..... 12
  - Horn Speaker Fail..... 12
  - Sensor Watch Fail ..... 12
  - Telephone Line Fail..... 12
- Fault Descriptions 12
  - Communciation Fail ..... 12
  - System Fault..... 12
- FAULT Indicator 7, 17
- Features 5
- Fire Alarm 11
- Forced Arming 8, 20
- Fuse Fail 12

## H

- Hand Held Remote Control 20
- Handover Delay 20
- Horn Speaker Fail 12
- Horn Speaker Test 14

## I

- Isolating 20
- Isolating Zones 11
  - Code to Isolate ..... 11
  - Standard Isolating ..... 11

	<b>M</b>			
MAINS Indicator	6, 17		STAY Mode 1	8, 21
Master Code	20		Entry Guard Timer .....	8
Master Partitioned Codepad Indicators	17		STAY Mode 2	8, 21
Medical Alarm	11		Entry Guard Timer .....	8
Monitoring Station	20		Programming Zones.....	9
	<b>O</b>		Strobe Indications	10
Off Indicator	7		Strobe Test	14
On Indicator	7		System Disarmed	6
Operating From A Master Partitioned Codepad	17			<b>T</b>
Operating From Area Addressable Codepads	17		Tamper Alarm	11
	<b>P</b>		Telco Arm Sequence	13, 21
Pager Reporting	18		Telco Disarm Sequence	21
Panic Alarm	10, 20		Telephone Line Fail	12
PARTIAL Indicator	17		Test Report	14
Partitioning	17		Testing	
	<b>R</b>		Bell Test.....	14
Radio User Codes			Horn Speaker Test.....	14
Adding .....	9		Strobe Test.....	14
Deleting.....	9		Test Report .....	14
Remote Arming	15		Walk Test.....	14
Remote Control	20			<b>U</b>
	<b>S</b>		Unsealed	21
Sealed	20		User Codes	21
Sensor Watch	20		Adding.....	9
Sensor Watch Fail	12		Adding Radio Users.....	9
Silent Alarm	21		Deleting.....	9
Speaker Beeps	10			<b>W</b>
Status Indicators	17		Walk Test	14
STAY Indicator	6			<b>Z</b>
			Zone Indicators	6, 17
			Zones	21

**Notes:**

Bosch Security Systems  
25 Huntingwood Drive  
Huntingwood NSW 2148  
Australia  
Phone: +612 9672 1777  
Facsimile: +612 9672 1717

© 2003 Bosch Security Systems  
S1920050  
Issue 112  
4998152467B

**BOSCH**